

**Podnośnik oparcia - P/L**  
**Nr 742.501 / 502**

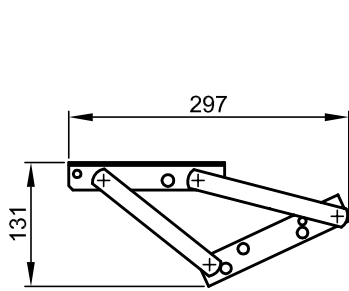

Wersja I

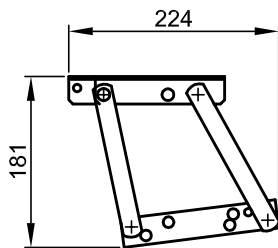
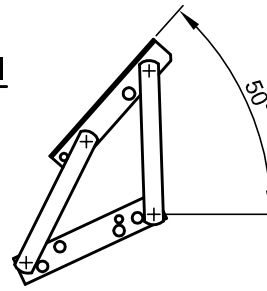

Wersja II

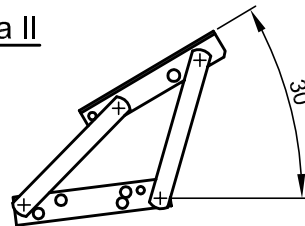

*Powłoka:*  
 - Cynkowany  
 - Lakierowany

tel. 52/346-41-76; fax. 52/372-62-05; [www.slawpol.bydgoszcz.pl](http://www.slawpol.bydgoszcz.pl); [slawpol@op.pl](mailto:slawpol@op.pl);

**Podnośnik nastawny**  
**RELAX - P/L**  
**Nr 742.503 / 504**

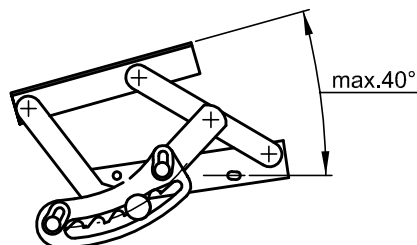
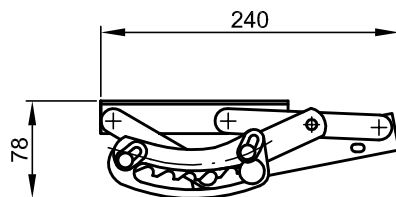

*Powłoka:*  
 - Cynkowany  
 - Lakierowany

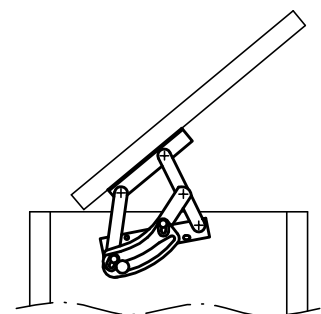
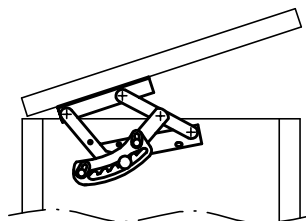
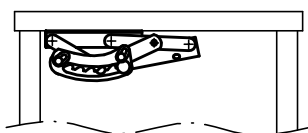

tel. 52/346-41-76; fax. 52/372-62-05; [www.slawpol.bydgoszcz.pl](http://www.slawpol.bydgoszcz.pl); [slawpol@op.pl](mailto:slawpol@op.pl);